

Quote Order

Purchase Order #

Client Name

COMPANY _____ SHIP TO _____

DATE _____ CITY _____

CONTACT NAME _____ STATE | PROV _____ ZIP | POSTAL _____

PHONE _____ EMAIL _____

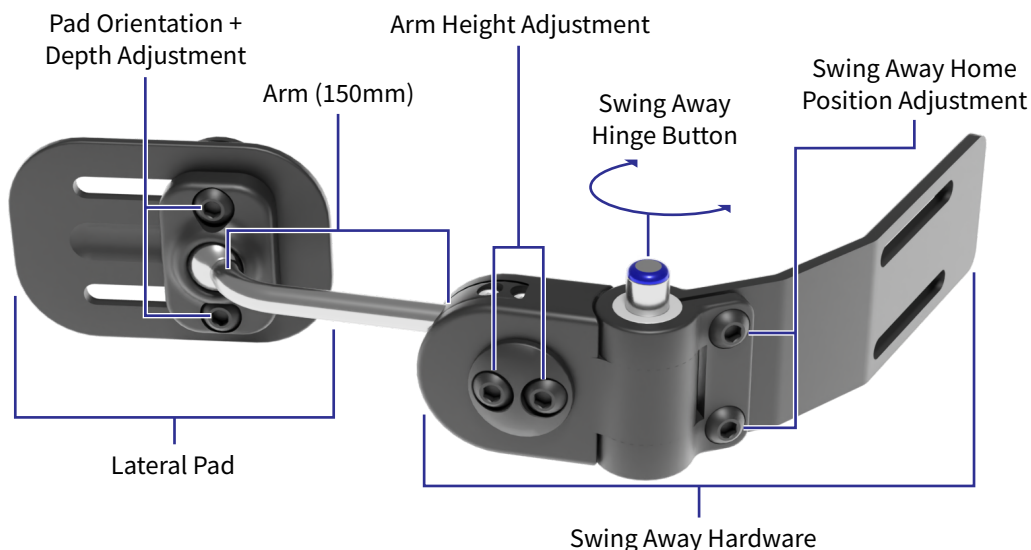

Back Plate Mount (BP)



OR

Cane Mount (CM)



Planar Pads

- Wide range of Planar Pad sizes
- Multi-layer Foam padding
- Compatible with a wide variety of Back Support systems **AND** most standard wheelchair canes



Foam Padding

Free Form Pads

- Fully customizable Free Form Pad configurations
- Multi-layer Foam **OR** Stimulite padding
- Compatible with Back Support systems **OR** most standard wheelchair canes



Stimulite Padding

Continued on next page...

PLANAR PAD SUPPORT
(Swing Away Hardware included)

MODEL	MSRP	LEFT	RIGHT	BACK MOUNT	CANE MOUNT
LUBS34	\$607	<input type="checkbox"/>	<input type="checkbox"/>	<input type="checkbox"/>	<input type="checkbox"/>
LUBS35	\$607	<input type="checkbox"/>	<input type="checkbox"/>	<input type="checkbox"/>	<input type="checkbox"/>
LUBS45	\$607	<input type="checkbox"/>	<input type="checkbox"/>	<input type="checkbox"/>	<input type="checkbox"/>
LUBS46	\$607	<input type="checkbox"/>	<input type="checkbox"/>	<input type="checkbox"/>	<input type="checkbox"/>
LUBS56	\$607	<input type="checkbox"/>	<input type="checkbox"/>	<input type="checkbox"/>	<input type="checkbox"/>
LUBS57	\$607	<input type="checkbox"/>	<input type="checkbox"/>	<input type="checkbox"/>	<input type="checkbox"/>

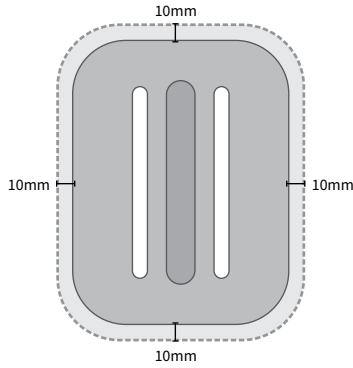

Planar Pad Configuration



STANDALONE SWING AWAY HARDWARE

ARM LENGTH	MODEL	MSRP	LEFT	RIGHT	BACK MOUNT	CANE MOUNT
*3 7/8" (10 cm)	LUBSAH	\$397	<input type="checkbox"/>	<input type="checkbox"/>	<input type="checkbox"/>	<input type="checkbox"/>

*Note: Mounting arm can be cut to desired length
Back Mount shown above. Also available with Cane Mount.

*L.U.B.S. Pads increase profile of the plates on all sides by 10mm.
Replacement pads sold separately for: \$209/each

L.U.B.S. PLATE DIMENSIONS

Diagram to scale when printed at 100% size on 8.5 x 11" standard paper.

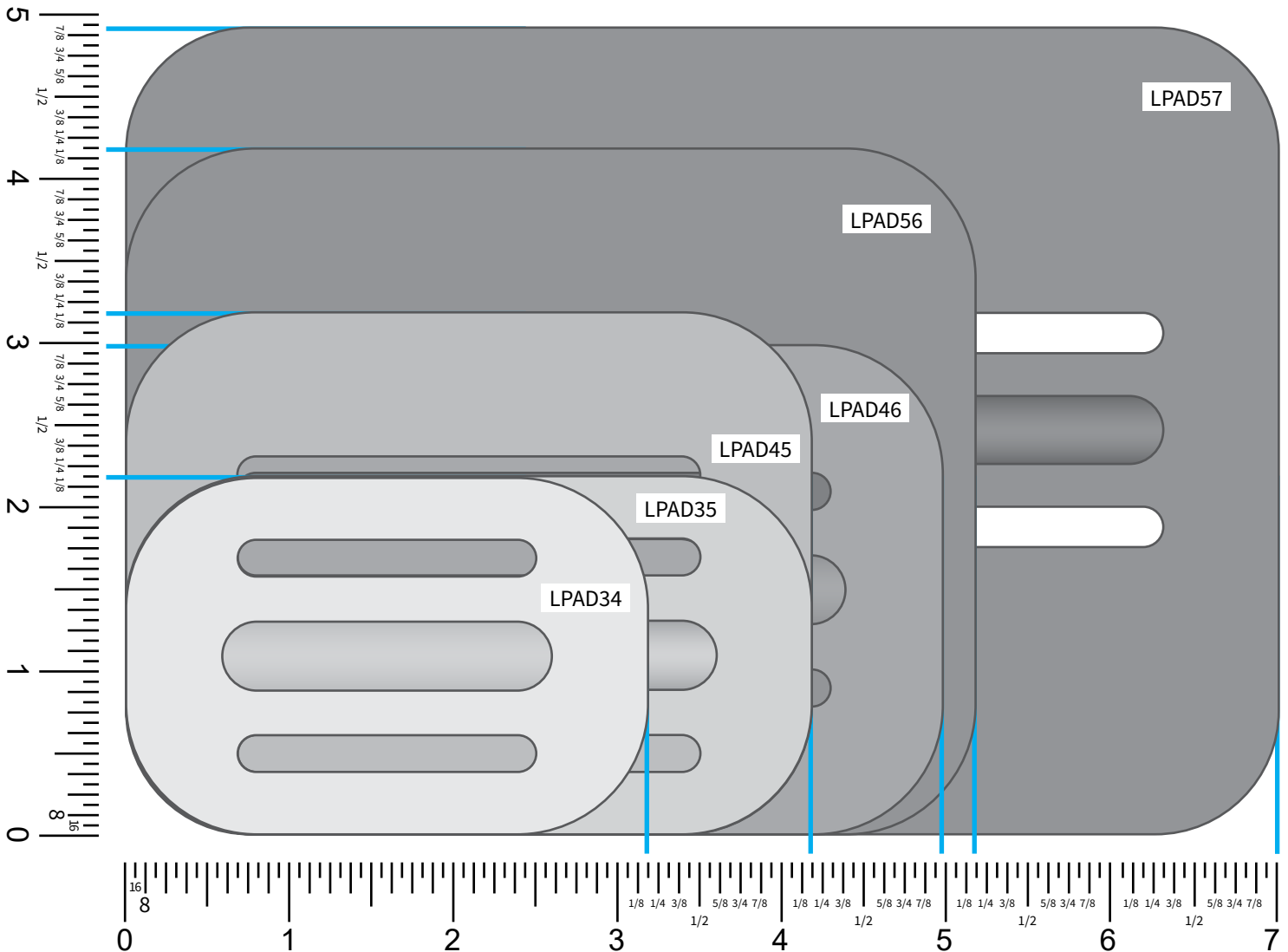

Prices are subject to change without notice.

FREE FORM SUPPORT
(Swing Away Hardware included)

WIDTH	HEIGHT	MODEL	MSRP	LEFT	RIGHT	BACK MOUNT	CANE MOUNT	FOAM	STIMULITE (+\$49)
4" (10 cm)	4" (10 cm)	LUBSFF3	\$797	<input type="checkbox"/>	<input type="checkbox"/>	<input type="checkbox"/>	<input type="checkbox"/>	<input type="checkbox"/>	<input type="checkbox"/>
4" (10 cm)	5 5/8" (14 cm)	LUBSFF4	\$832	<input type="checkbox"/>	<input type="checkbox"/>	<input type="checkbox"/>	<input type="checkbox"/>	<input type="checkbox"/>	<input type="checkbox"/>
4" (10 cm)	6 7/8" (17 cm)	LUBSFF5	\$867	<input type="checkbox"/>	<input type="checkbox"/>	<input type="checkbox"/>	<input type="checkbox"/>	<input type="checkbox"/>	<input type="checkbox"/>
6" (15 cm)	6 7/8" (17 cm)	LUBSFF7	\$902	<input type="checkbox"/>	<input type="checkbox"/>	<input type="checkbox"/>	<input type="checkbox"/>	<input type="checkbox"/>	<input type="checkbox"/>
6" (15 cm)	9 1/4" (23 cm)	LUBSFF10	\$937	<input type="checkbox"/>	<input type="checkbox"/>	<input type="checkbox"/>	<input type="checkbox"/>	<input type="checkbox"/>	<input type="checkbox"/>
-	-	LUBSFFCUST	Per Request	<input type="checkbox"/>	<input type="checkbox"/>	<input type="checkbox"/>	<input type="checkbox"/>	<input type="checkbox"/>	<input type="checkbox"/>

Free Form Pad Configuration



Free Form LUBS provides the ability to create a custom contoured trunk support pad. Each size comes with a removable Free Form padded cover and swing-away hardware.

LUBSFF3



LUBSFF4



LUBSFF5



LUBSFF7

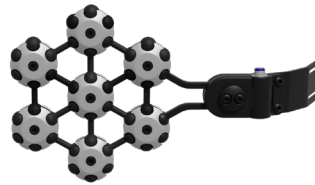

LUBSFF10

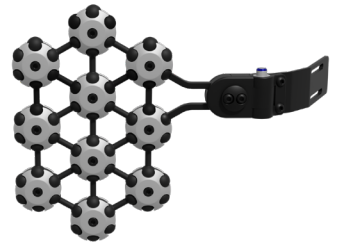

CUSTOM SHAPE FREE FORM SUPPORT

(Swing Away Hardware included)

LEFT	RIGHT
<input type="checkbox"/>	<input type="checkbox"/>

Select Left and/or Right, then fill in the diagrams to select nodes to be included in a custom shaped pad for a Free Form Lateral Support (**not to scale**). When this order form is complete, click "Submit" at the bottom of this page.

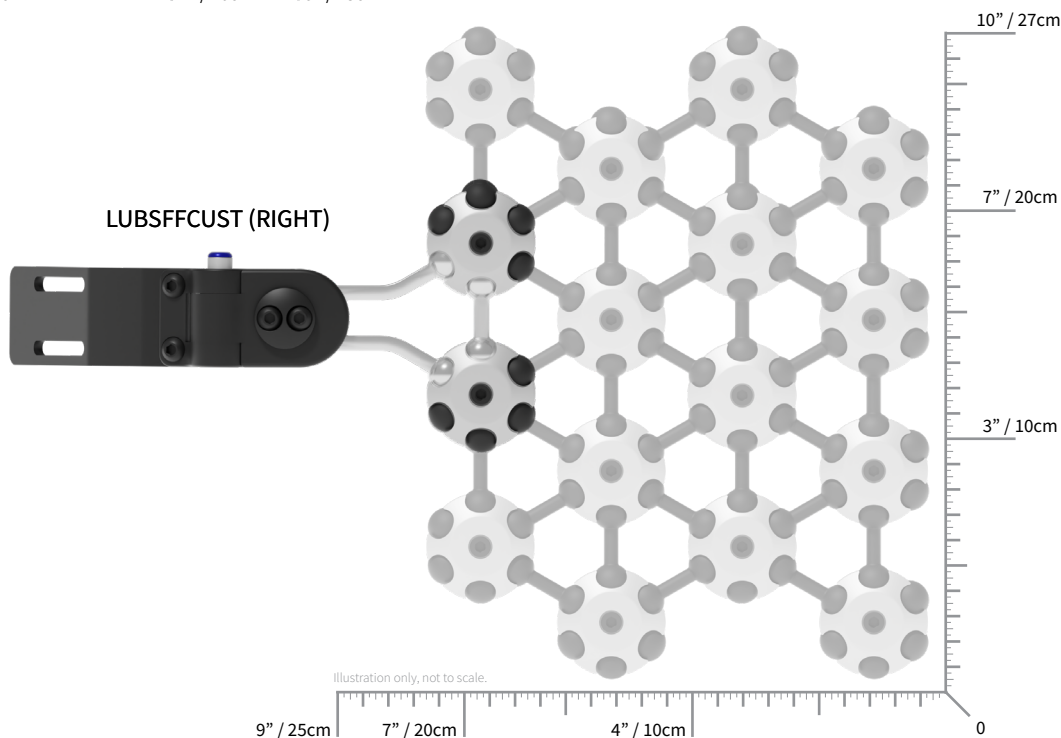
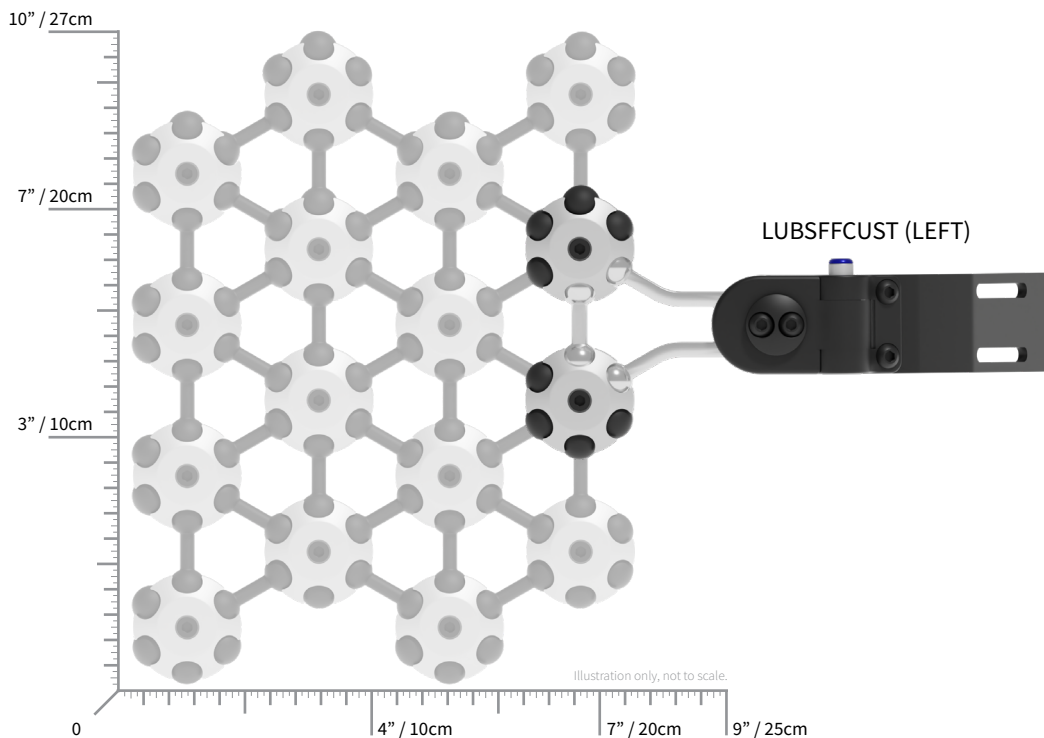

Use "Print" with ".pdf" selected as the destination printer to generate a file of the completed form to be submitted.

*Use with local .pdf file only. Download this file to use "Submit".

Prices are subject to change without notice.